

Installation instructions for KZNG5-03901-00, KZNG5-03902-00
Under Run Protective Shield Reduction Gearbox

TOYOTA HIGHLANDER



Model Year

HIGHLANDER 2019-

Applicability:

Highlander IV (U70) 3,5 L

Part Number

Steel: KZNG5-03901-00

Aluminium: KZNG5-03902-00



Weight

Steel: 1,53 kg

Aluminium: 0,98 kg



Installation Time

30 min

KZNG5-03901-00, KZNG5-03902-00

A

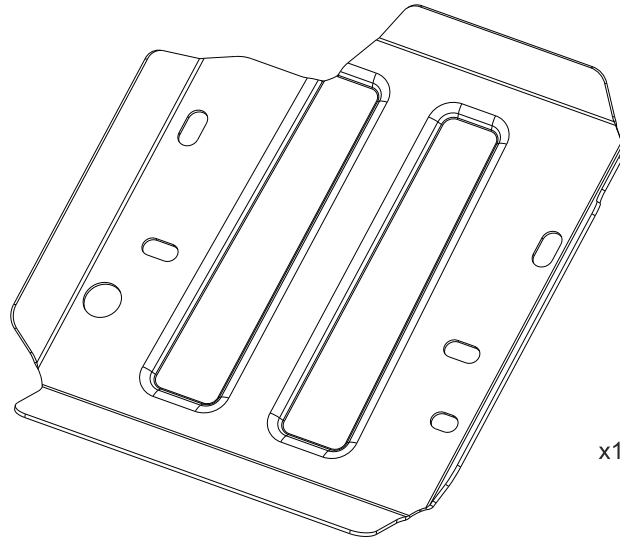

KZNG5-03901-60

B1

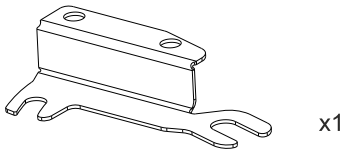

B2

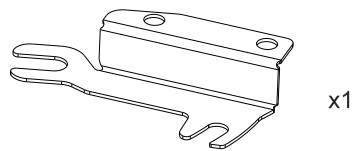

C



D

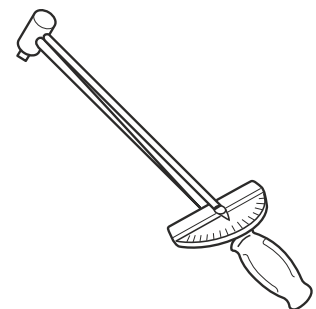
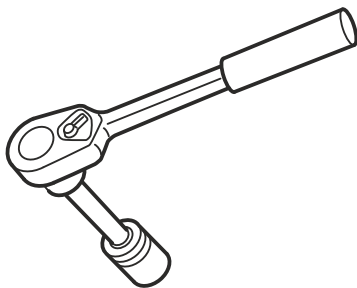

1

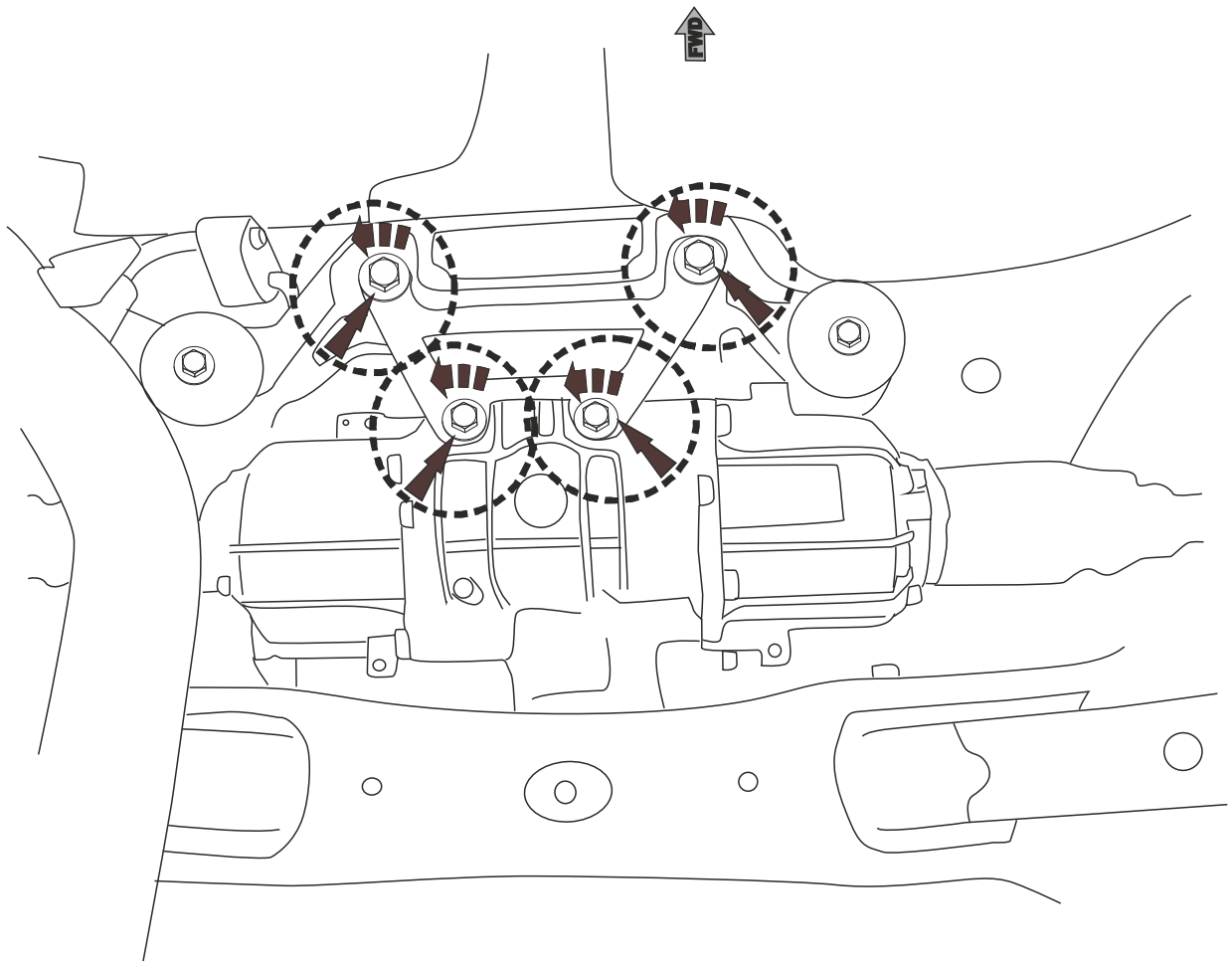

2

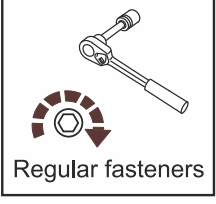
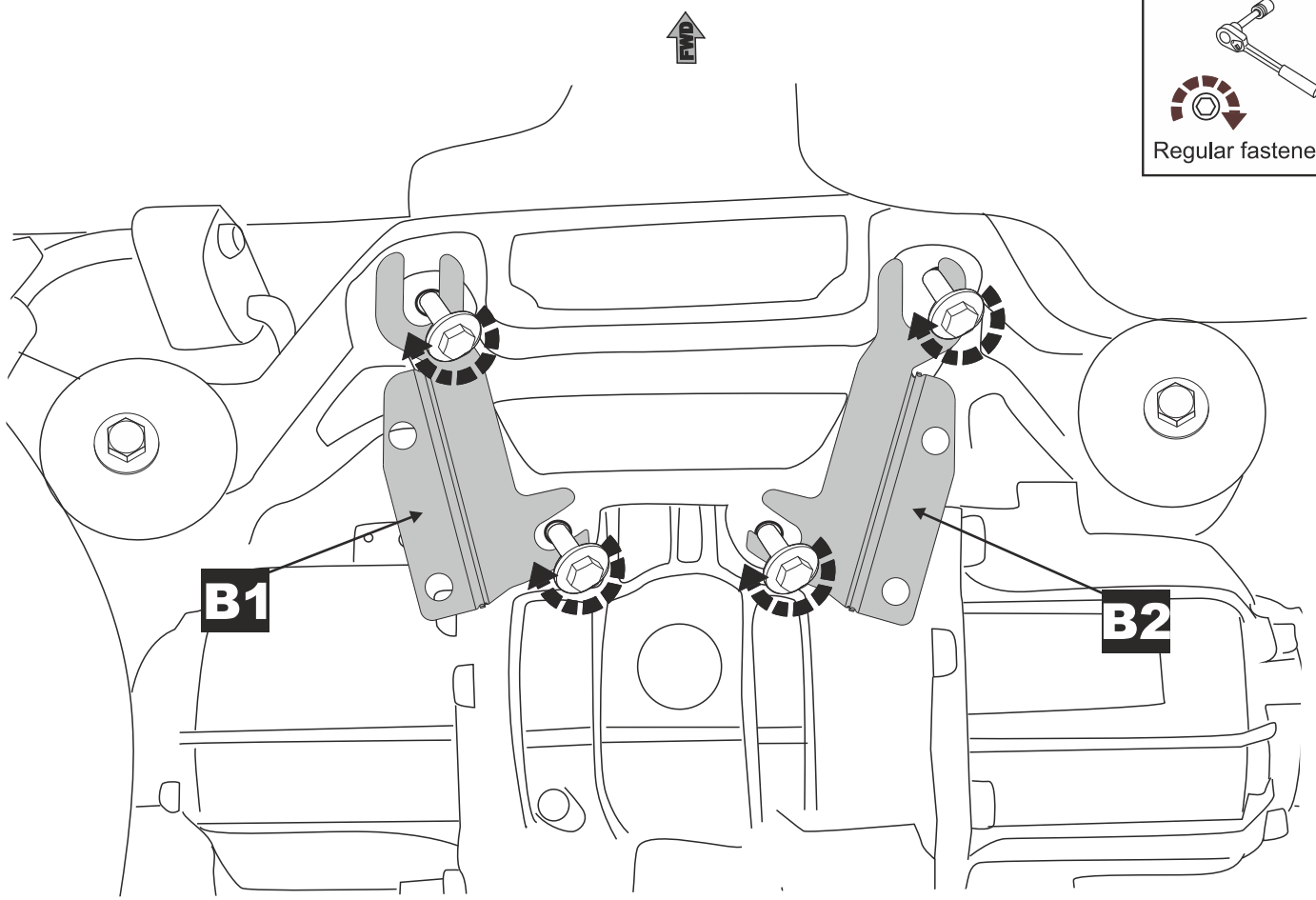

B1

B2

