

Installation instructions for KZNG5-03826-00, KZNG5-03827-00
Under Run Protective Shield TRANSMISSION CASE

**SKID PLATE INSTALLED TOGETHER WITH ENGINE BAY
KZNG5-03828-00/KZNG5-03829-00.**

TOYOTA LAND CRUISER 300



ModelYear

LAND CRUISER 2021-

Applicability:

CRUISER 3,5 AT 4WD

PartNumber

Steel: KZNG5-03826-00
Aluminium: KZNG5-03827-00



Weight

Steel: 9,59 kg
Aluminium: 5,42 kg



InstallationTime

30 min

KZNG5-03826-00, KZNG5-03827-00

A

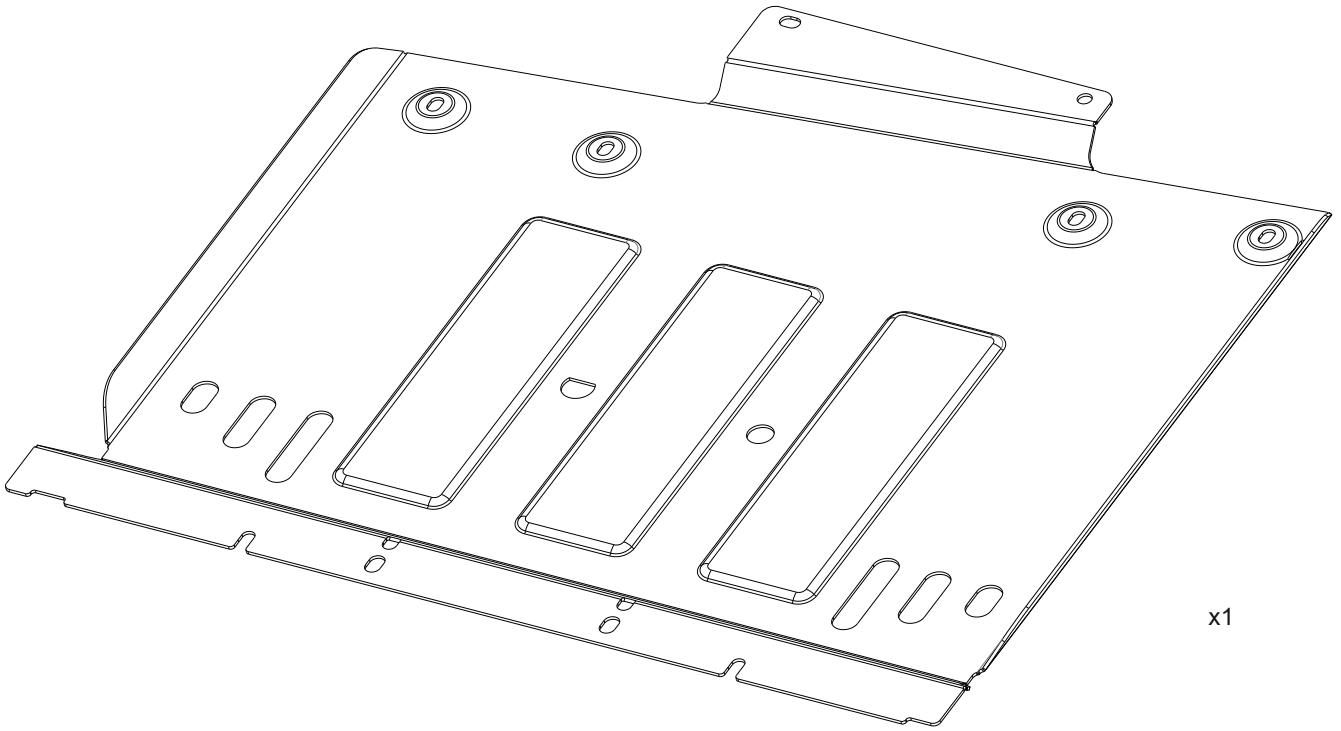

KZNG5-03826-60

B1

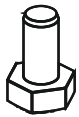

x6 M8x25

B2

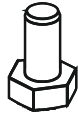

x4 M10x1,25x20

C



x4 M8

D

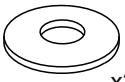

x2 Ø 8

E1

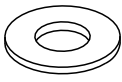

x10 Ø8

E2

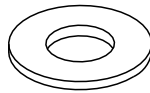

x4 Ø 10

F1



x6 Ø 8

F2



x4 Ø 10

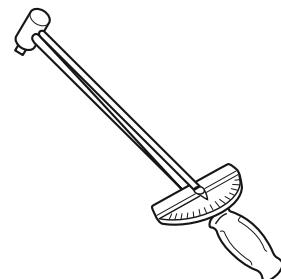
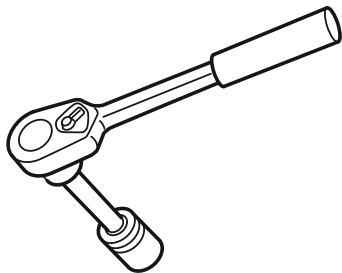

1

FWD ↑

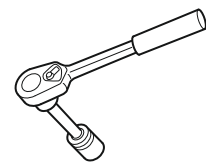

Regular fasteners



**KZNG5-03828-00/
KZNG5-03829-00**

