

Installation instructions for KZNG5-02063-00, KZNG5-02064-00
Under Run Protective Shield Engine Bay and Transmission Case

TOYOTA Prius Hybrid/Prius MC



TOYOTA Corolla



TOYOTA Auris



LEXUS CT200h



Model Year: Prius Hybrid/Prius MC 2009-/2011-	Corolla - 2007-2013	Corolla - 2013-	Auris - 2009-	Auris - 2012-	CT200h - 2007-
--	---------------------	-----------------	---------------	---------------	----------------

Vehicle Code	ZVW30L-AHXEBW	ZRE151L-AEFDKW ZRE151L-AEFNKW ZRE151L-AEPDKW ZRE151L-AEPNKW	ZRE181L-DEFDKW ZRE181L-DEFNKW ZRE181L-DEXDKW ZRE181L-DEXNKW ZRE182L-DEXNKW	ZRE151L-DHFDPW ZRE151L-DHPDKW ZRE151L-DHPNKW	ZRE185L-DHXNPW ZRE185L-DHXDPW NRE180L-DHFDPW	ZWA10L-AHXBBW Эко - ZWA10L-AHXEBW
--------------	---------------	--	--	--	--	--------------------------------------

Part Number

Steel: KZNG5-02063-00
Aluminium: KZNG5-02064-00



Weight

Steel: 9,16 kg
Aluminium: 5,71 kg



Installation Time

20 min

A

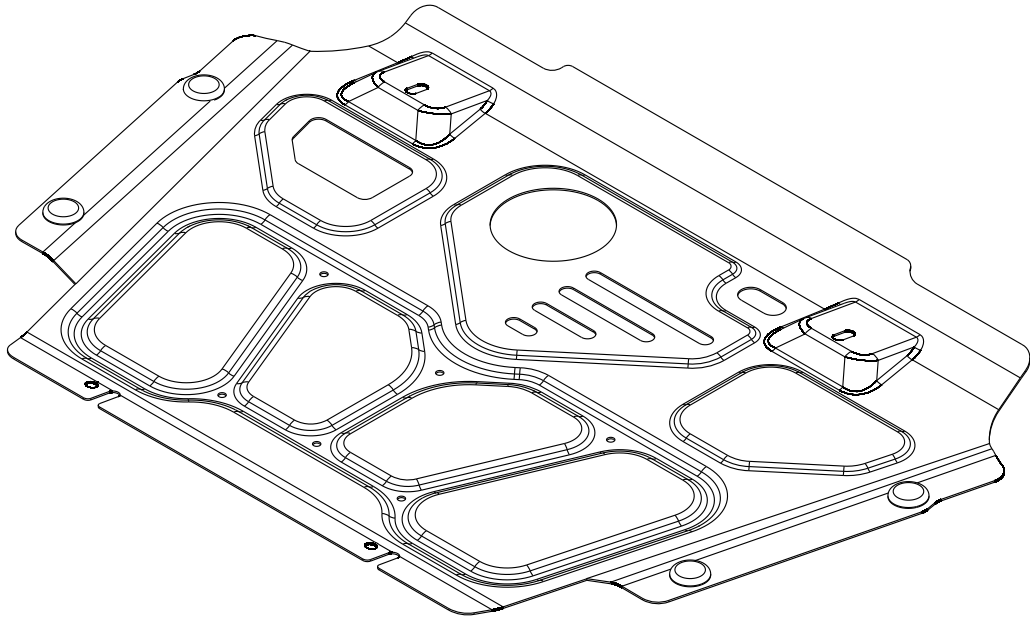

KZNG5-01093-60

B1



B2

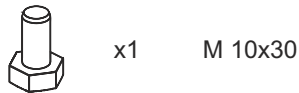

B3

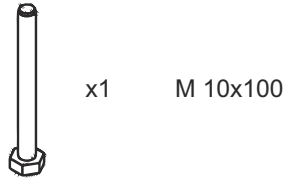

C

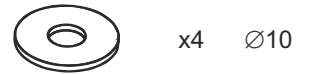

D

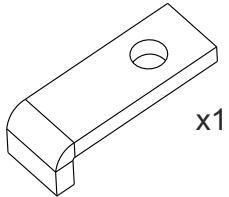

E

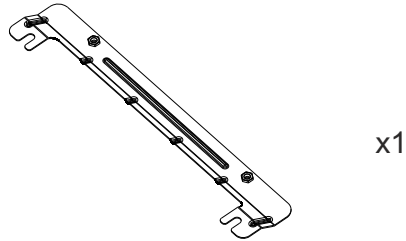

F

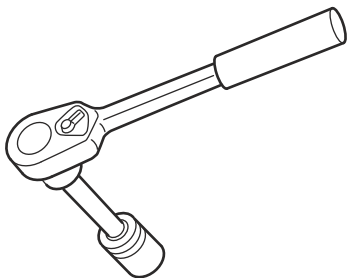
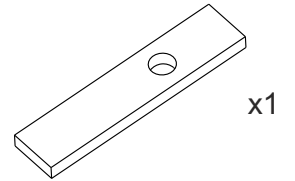

1

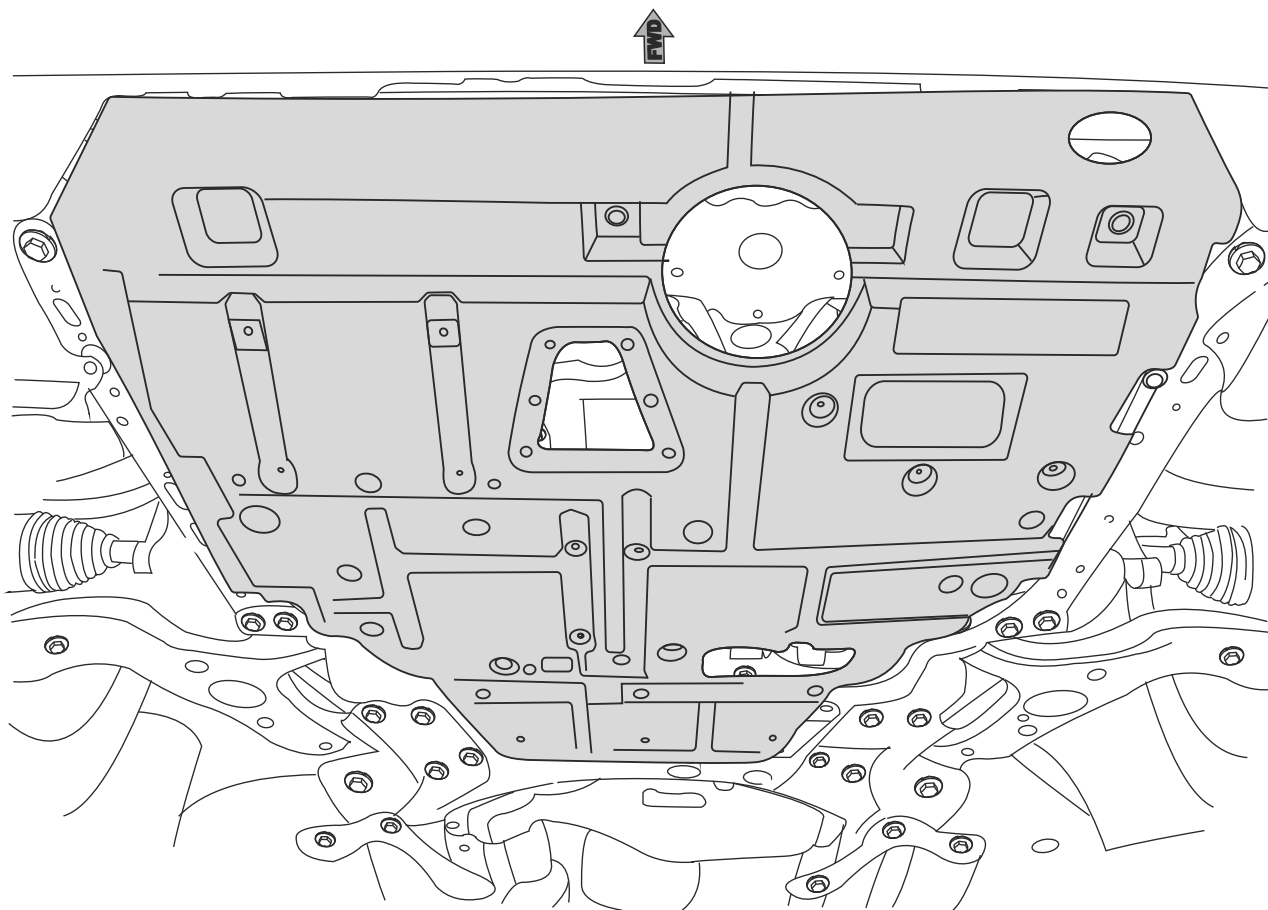

2

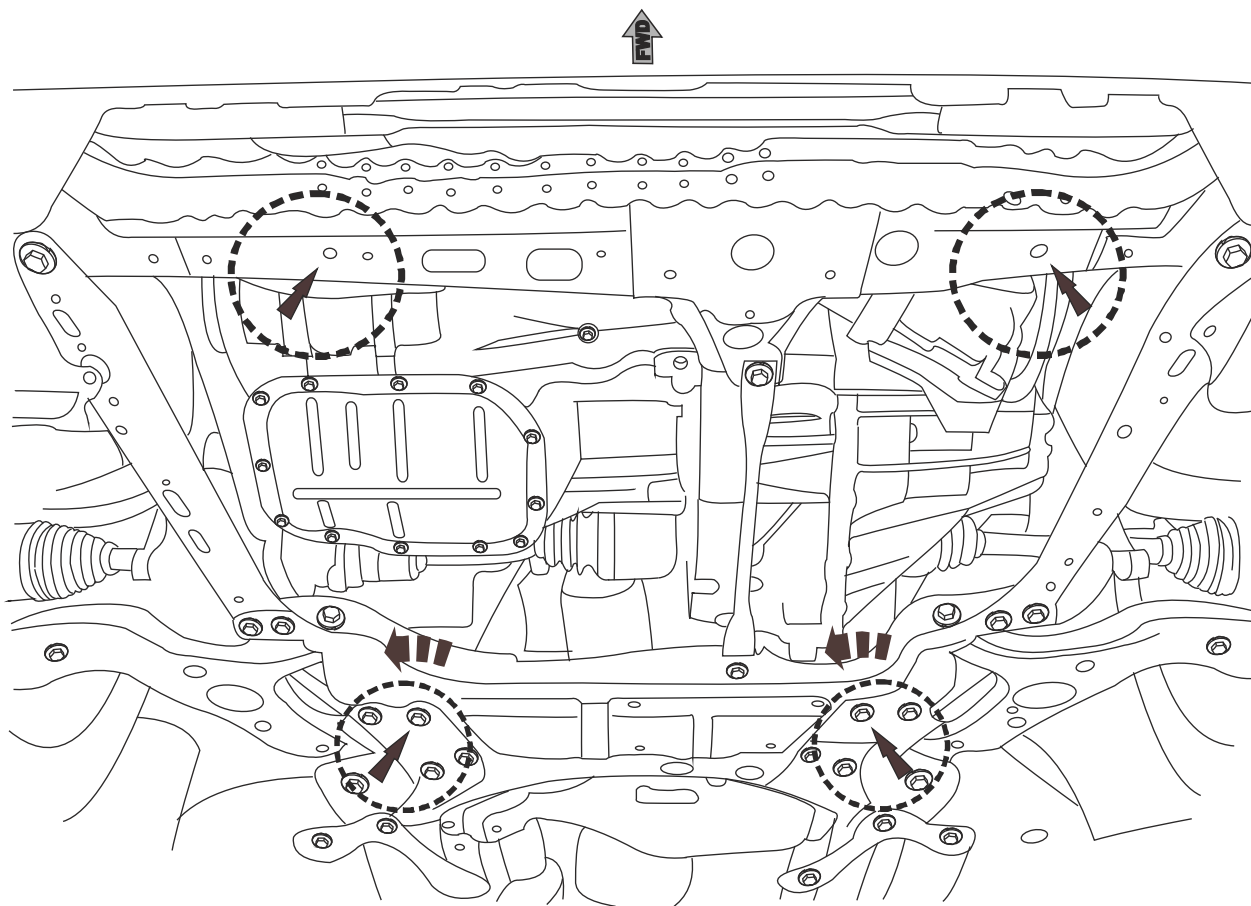

3

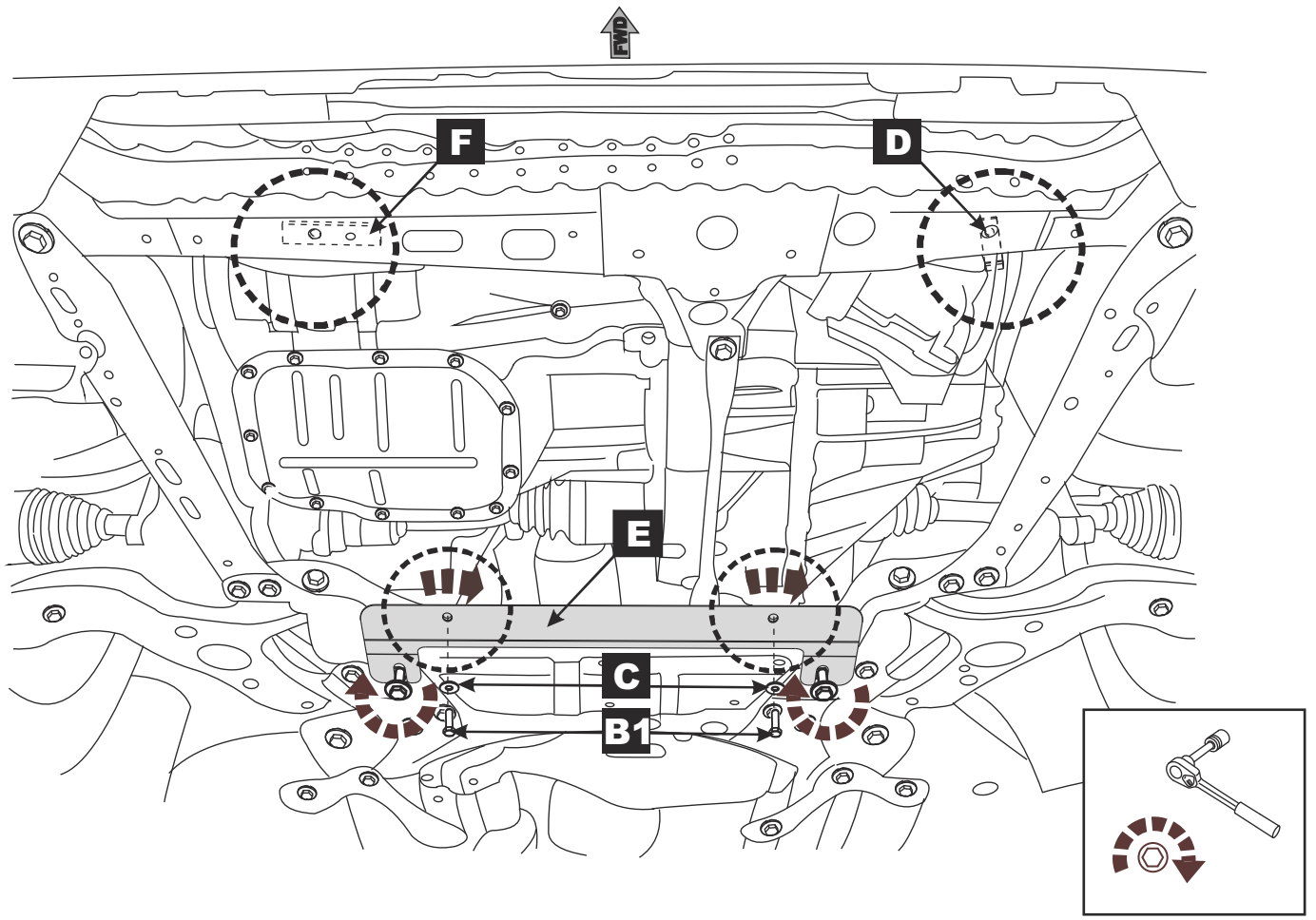

4

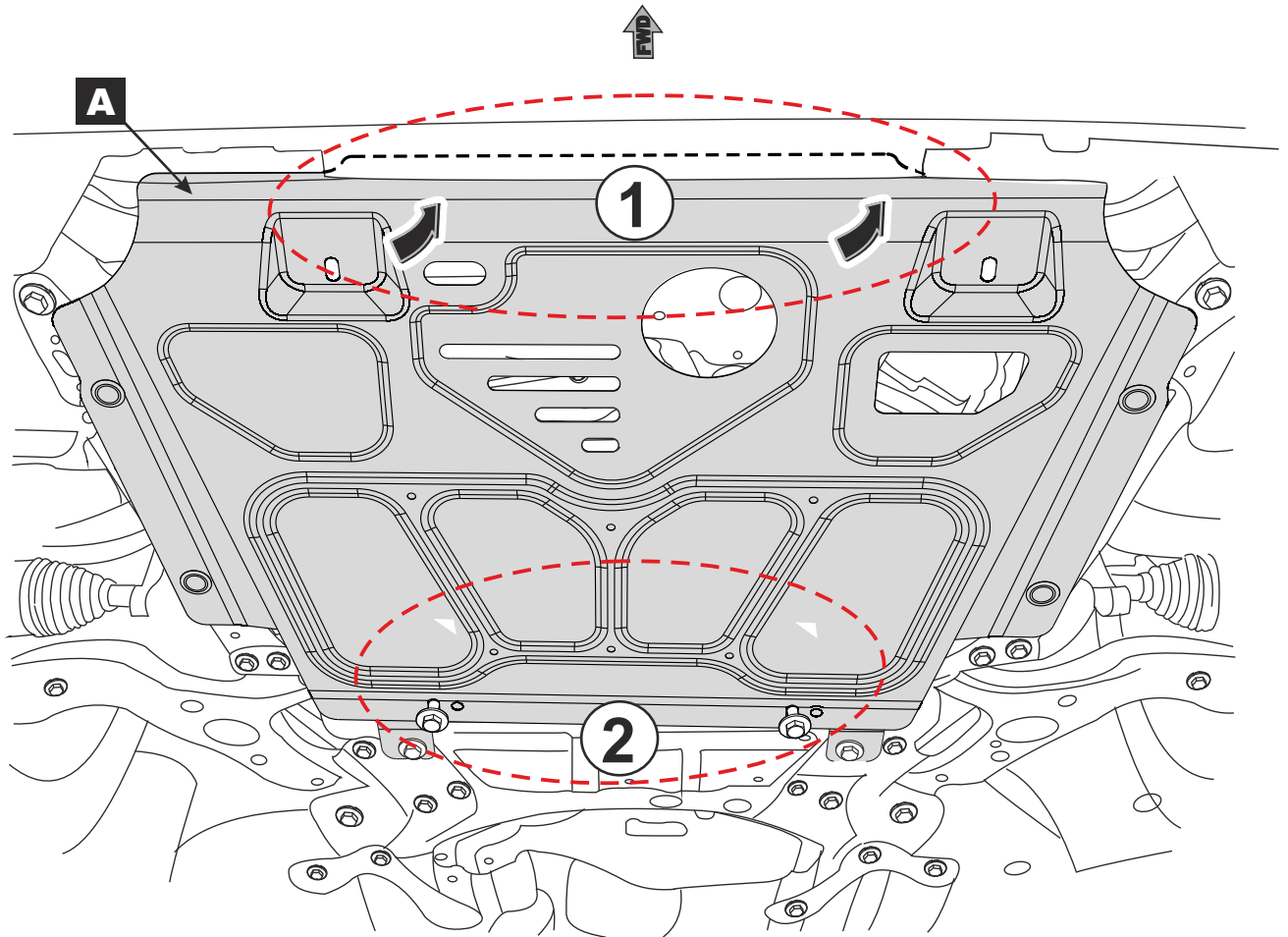

5

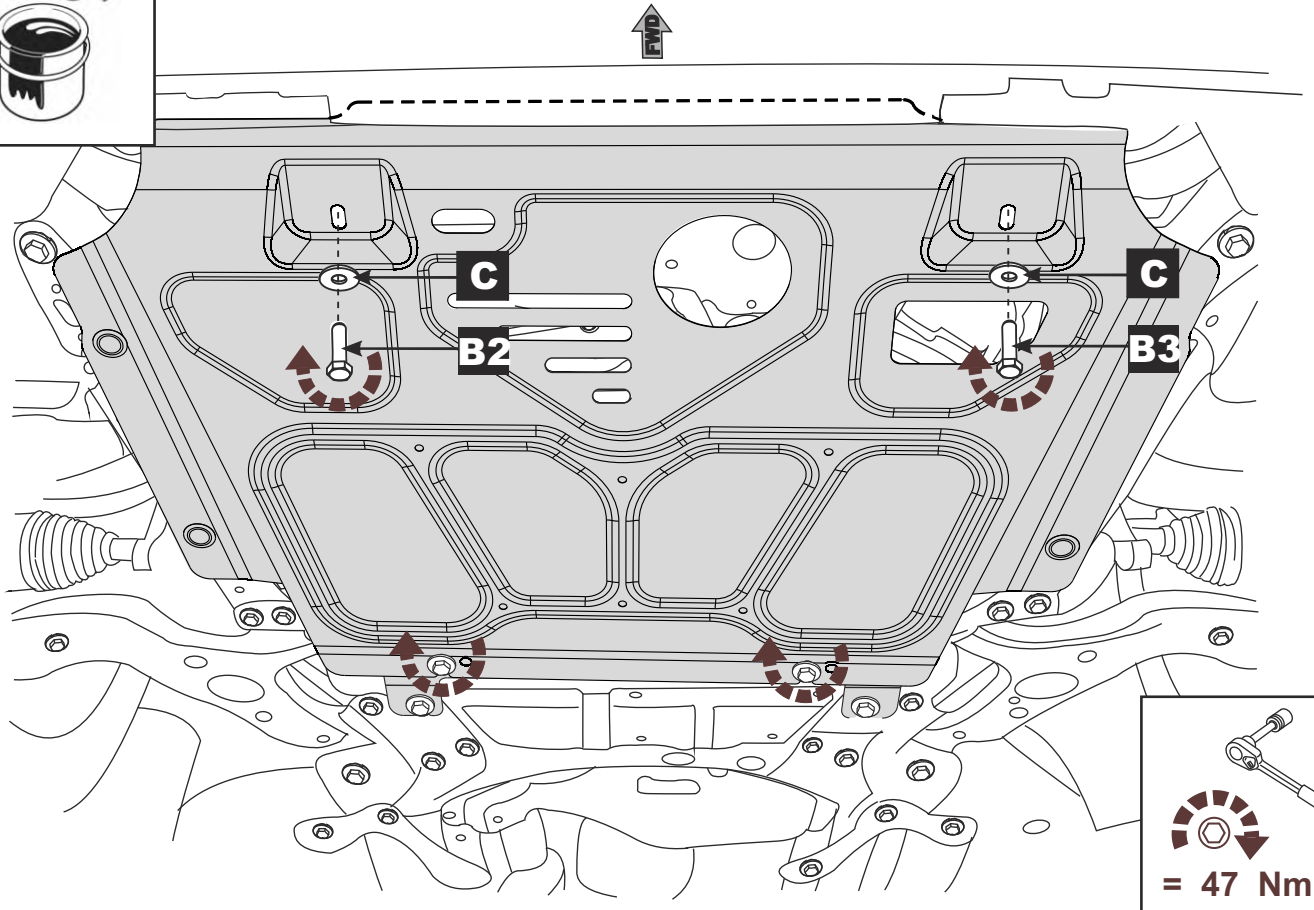

6

