

Installation instructions for KZNG5-3007-00, KZNG5-3008-00  
Under Run Protective Shield Fuel Tank

## TOYOTA LC 200



## LEXUS LX



### LC 200 (4.6L; 4,5TD)

### LX 570

### LX 450d

Model year:

2015

2015

2015

Applicability:

VDJ200L-GMTVZW

Part Number:

Steel: KZNG5-3007-00  
Aluminium: KZNG5-3008-00



Weight:

Steel: 17.27 kg  
Aluminium: 10.25 kg



Installation Time:

30 min

**A**

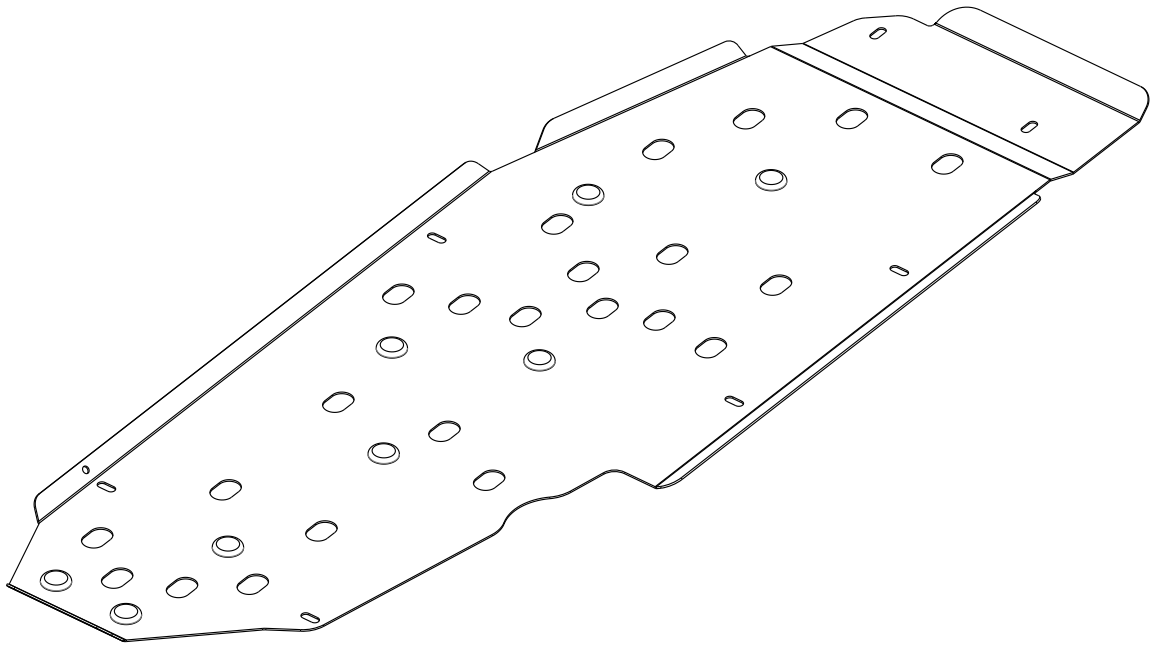

**KZNG5-01588-60**

**B**



1x

**C**



1x

**D**

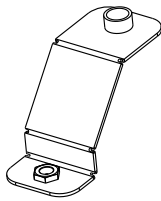

1x

**E**

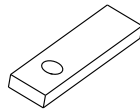

2x

**F**

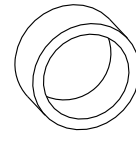

h=10

2x

**G1**

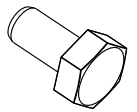

M8x30

5x

**G2**

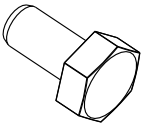

M10x20

3x

**G3**

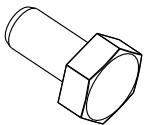

M10x30

2x

**H1**

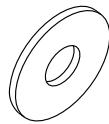

d=8

5x

**H2**

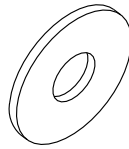

d=10

5x

**I1**



d=8

5x

**I2**

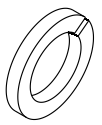

d=10

5x

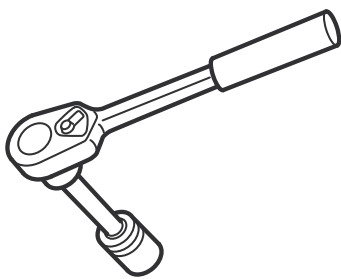

13 mm  
17 mm



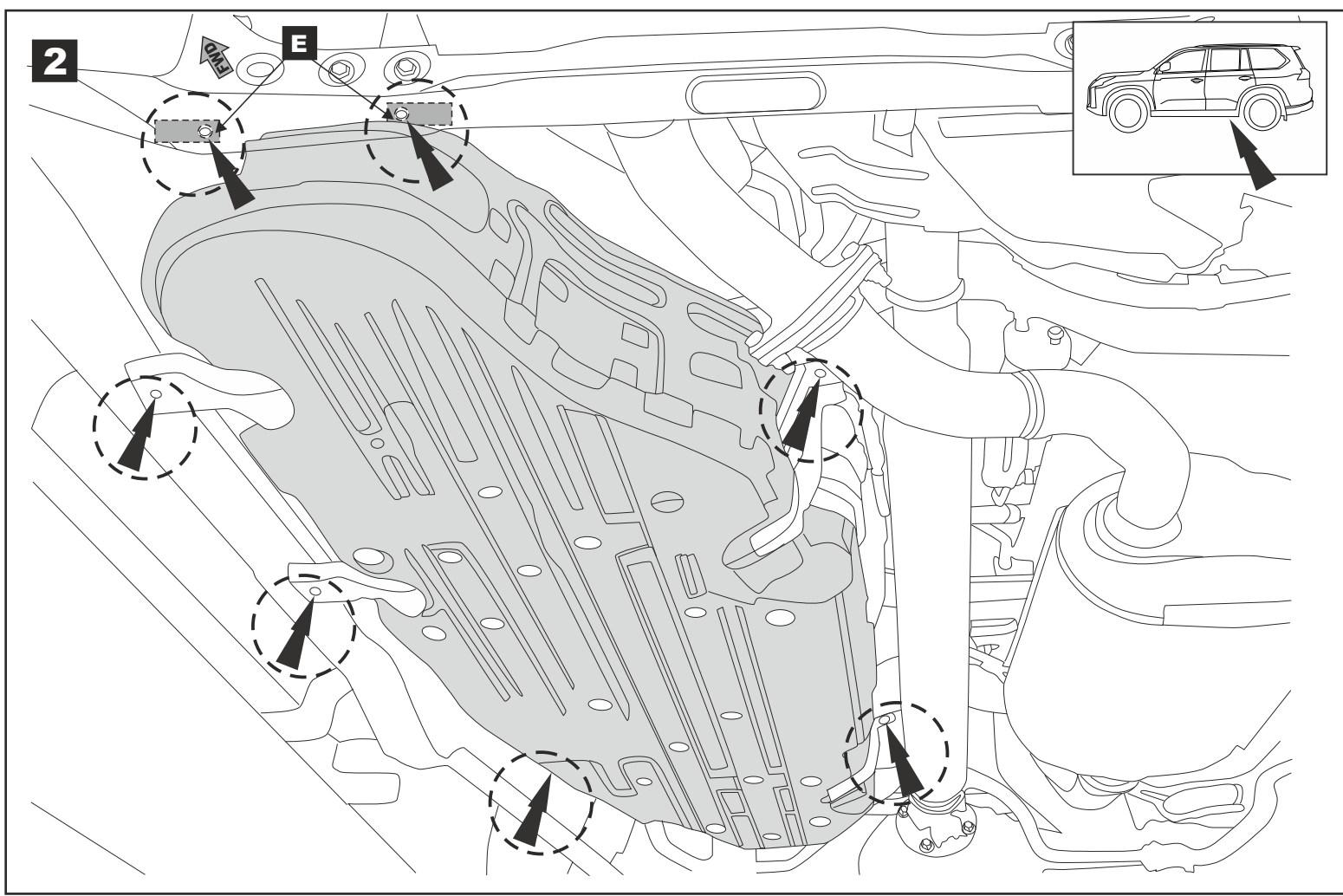
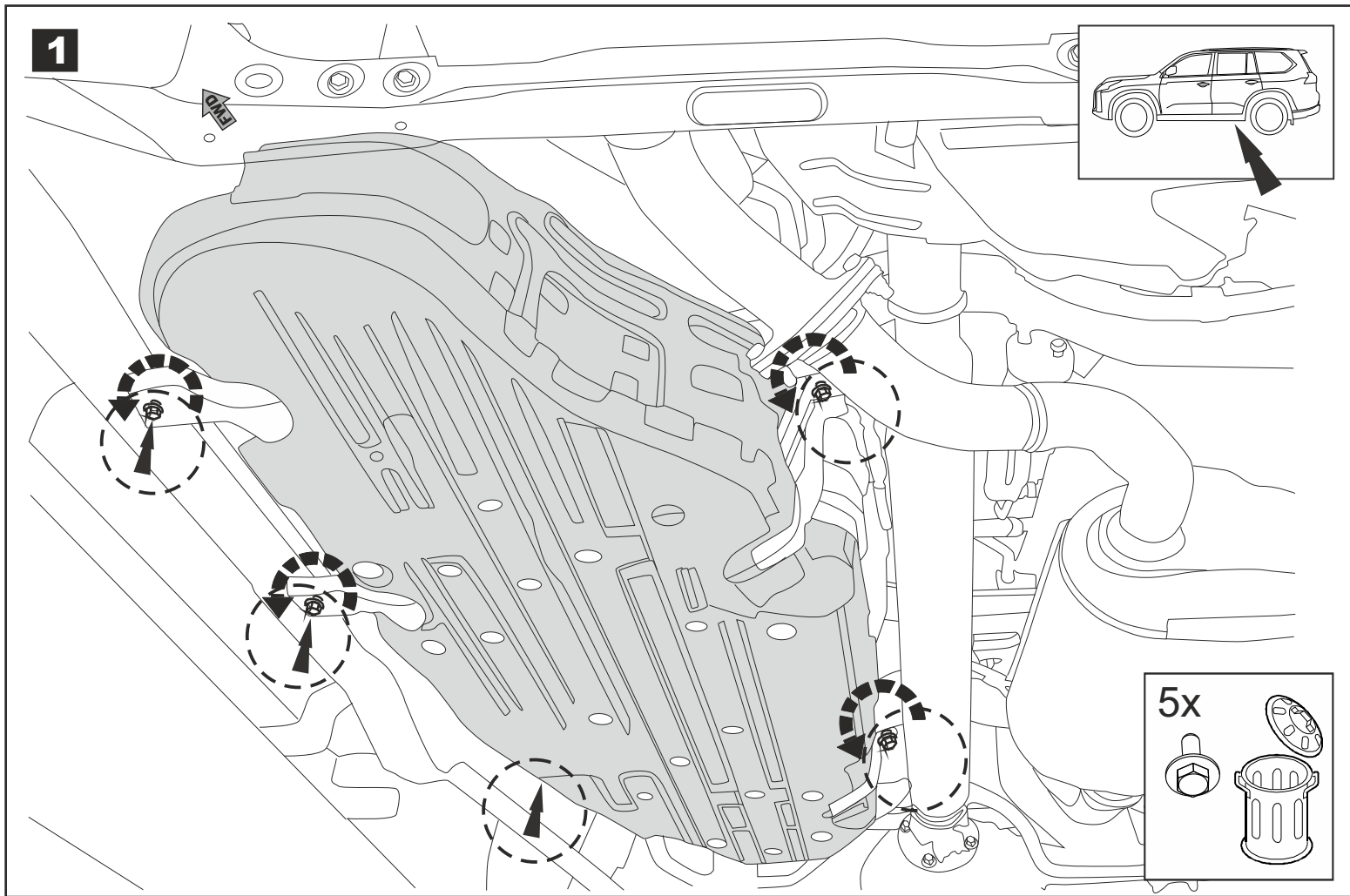

**3**

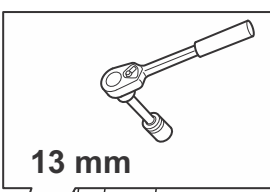
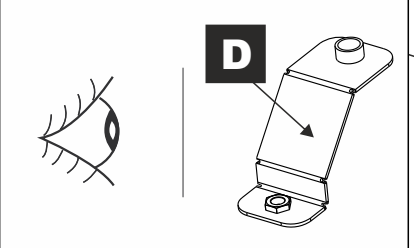
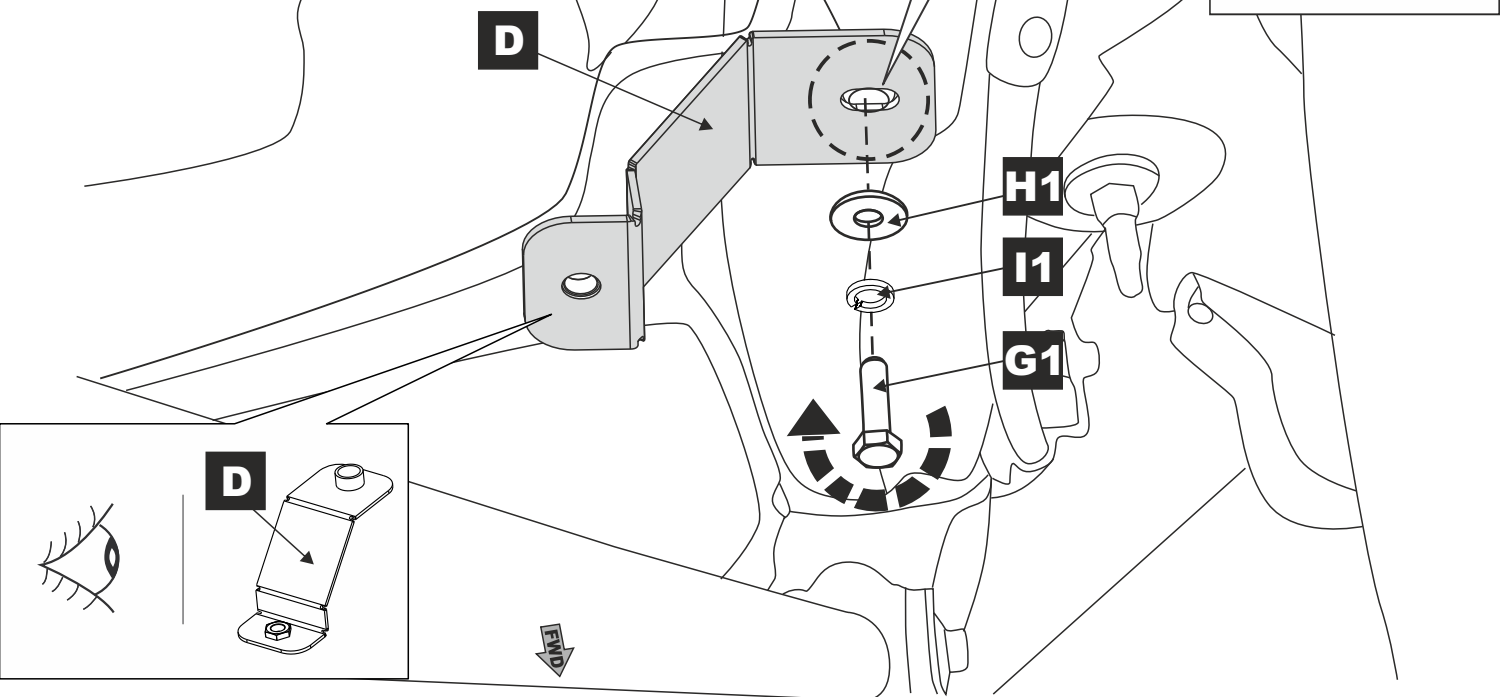
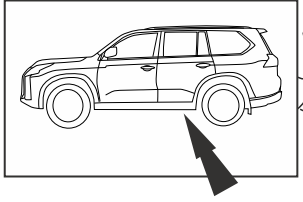

**4**

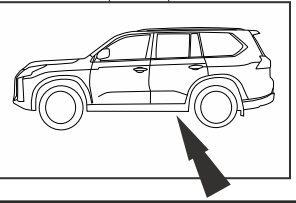
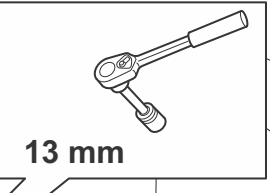
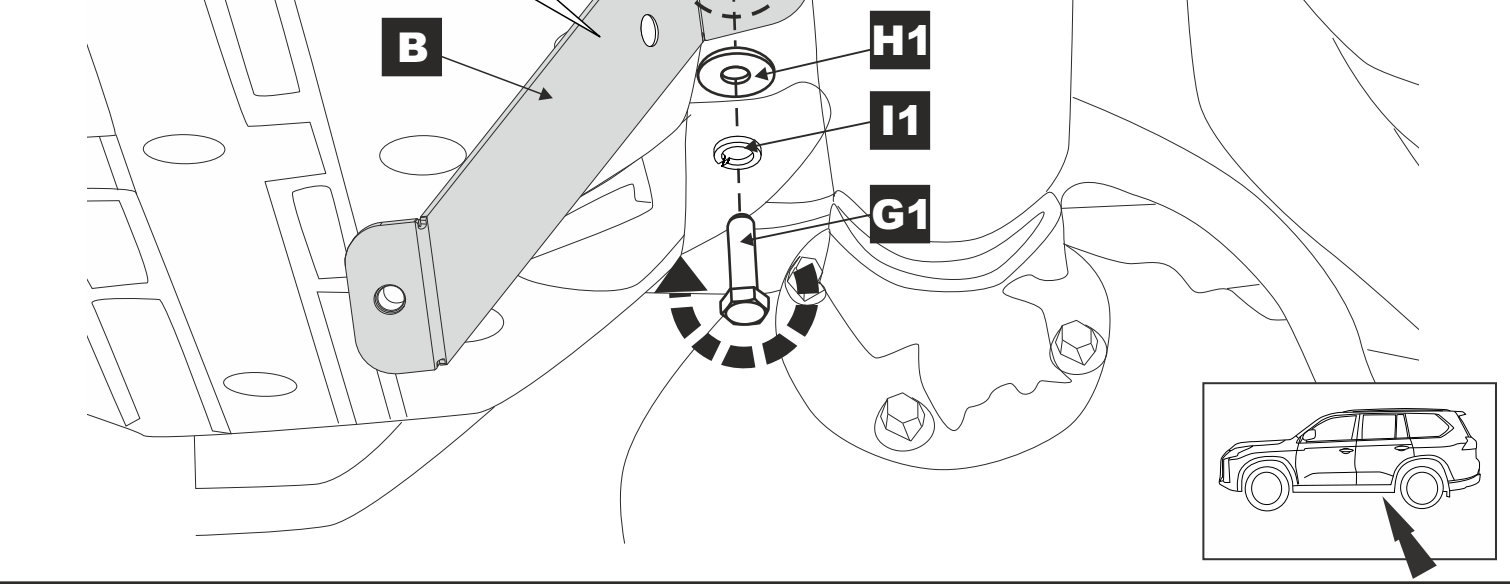
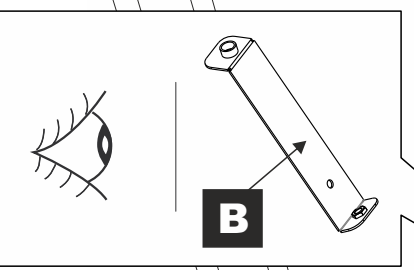

**5**

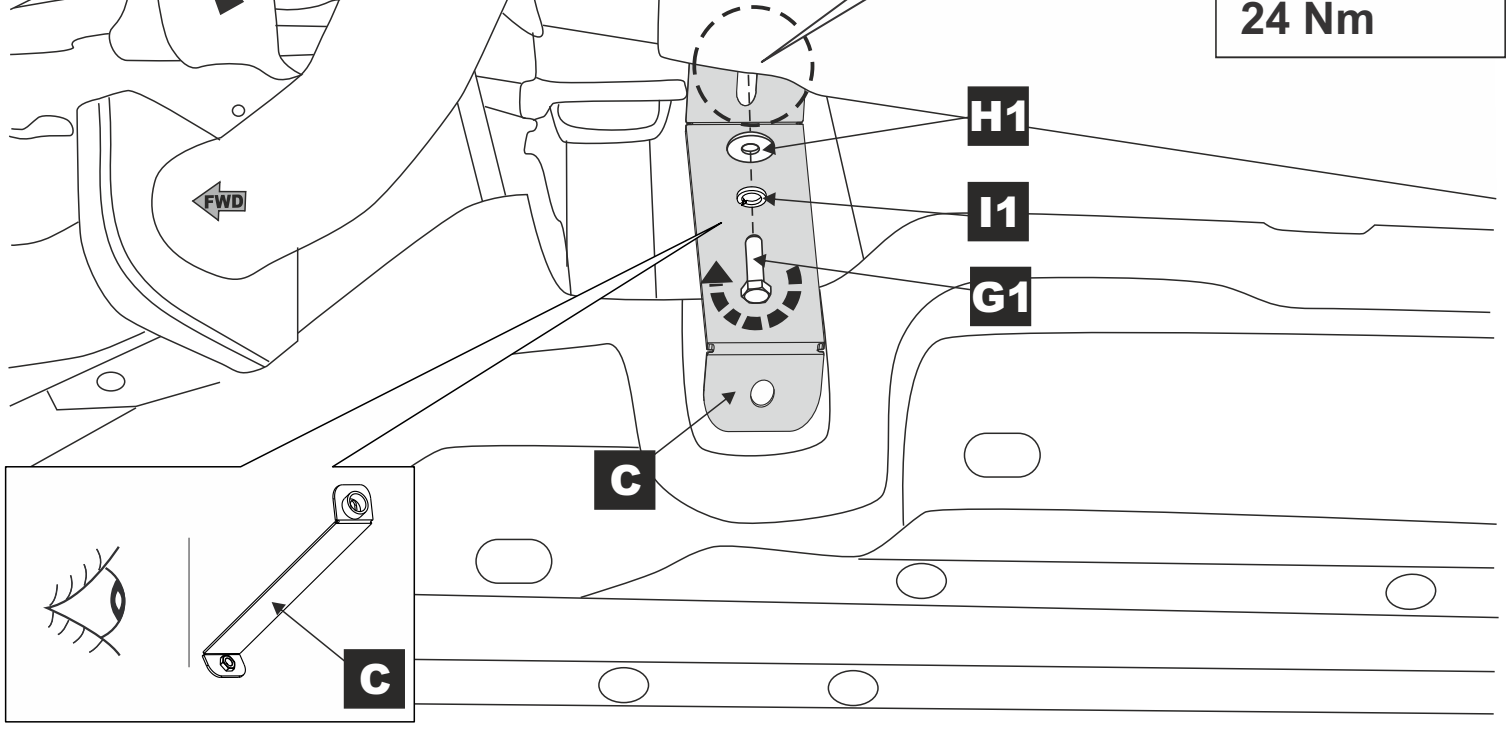
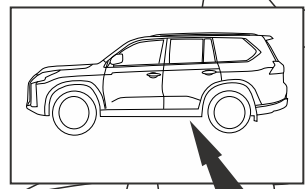

**6**

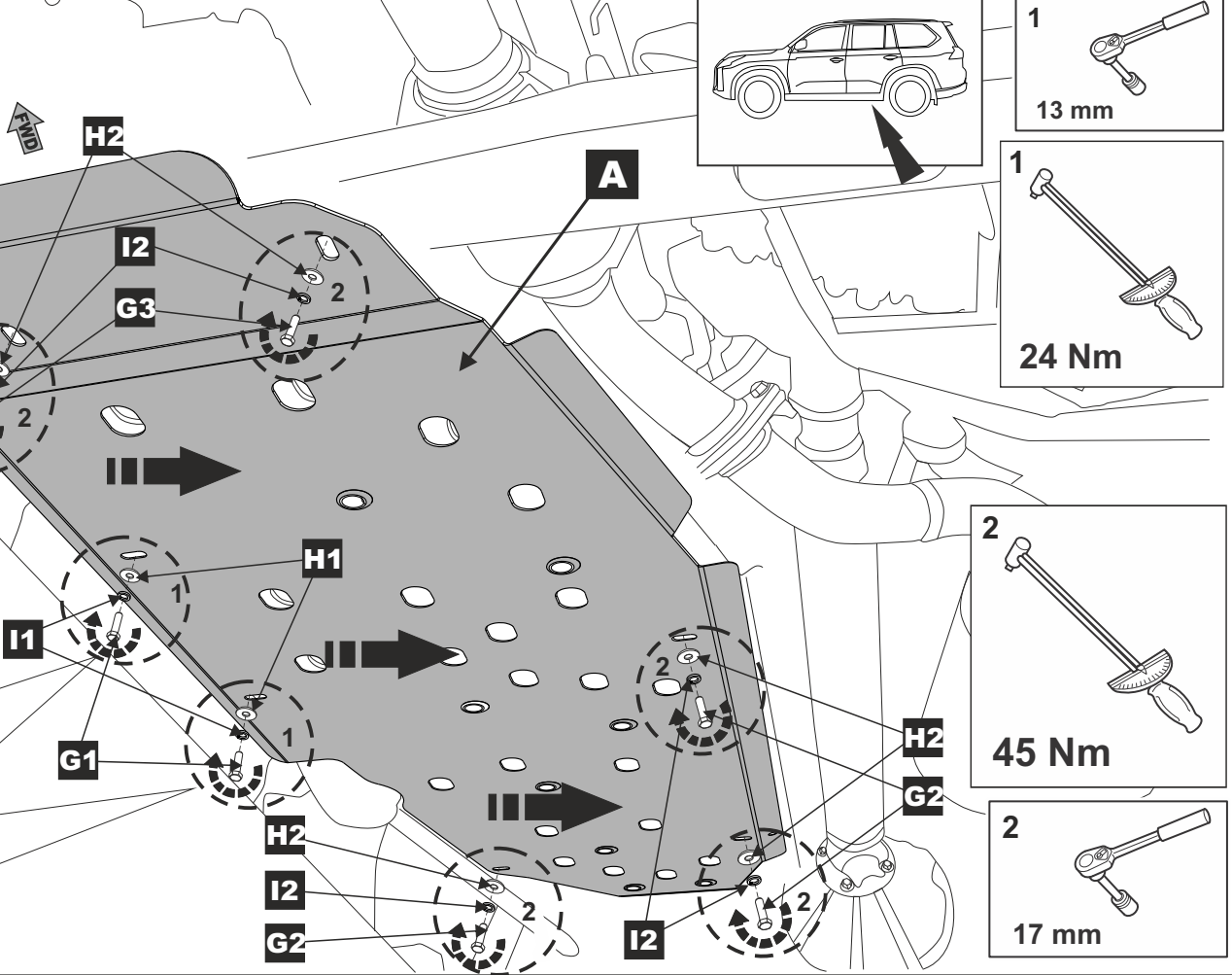

Part number:  
KZNG5-3007-00  
KZNG5-3008-00

Revision:  
1

Date:  
02.12.15

LC 200 2015; LX 450d 2015

Page:  
5/6

7

END

