



Installation instructions for KZNG5-3005-00, KZNG5-3006-00  
Under Run Protective Shield Transmission Case

## TOYOTA LC 200



## LEXUS LX



|  | <b>LC 200 (4,5TD)</b> | <b>LX 450d</b>                                   |
|--|-----------------------|--|
| Model year:  | 2015                  | 2015   |
| Applicability:   | VDJ200L-GMTVZW        |  |
| Part Number:   |                       | Steel: KZNG5-3005-00<br>Aluminium: KZNG5-3006-00 |
|  Weight:            |                       | Steel: 5.14 kg<br>Aluminium: 2.73 kg             |
|  Installation Time: |                       | 30 min   |

**A**

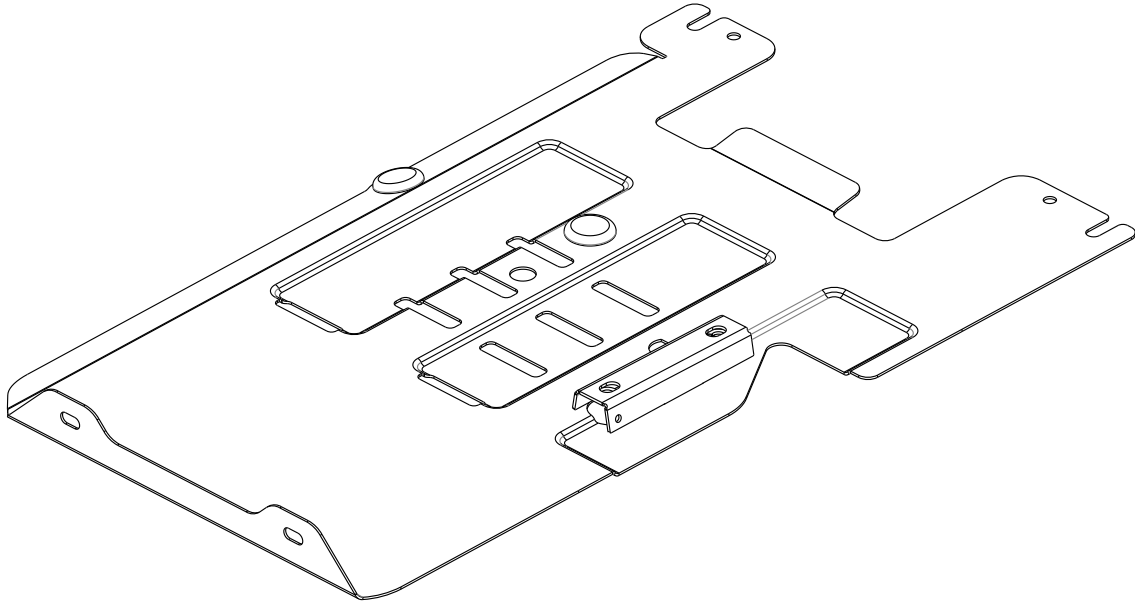

**KZNG5-03005-60**

**B1**

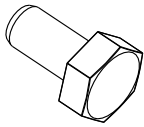

M8x20

4x

**B2**

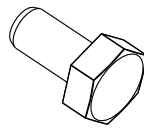

M10x1,25x20

2x

**C1**

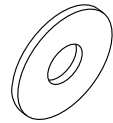

d=8

4x

**C2**

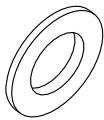

d=10

2x

**D1**

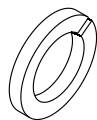

d=8

4x

**D2**



d=10

2x

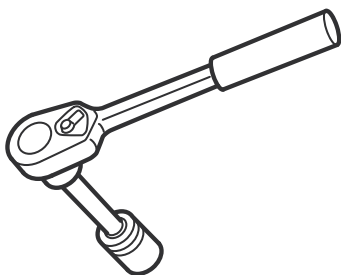

**13 mm**  
**17 mm**



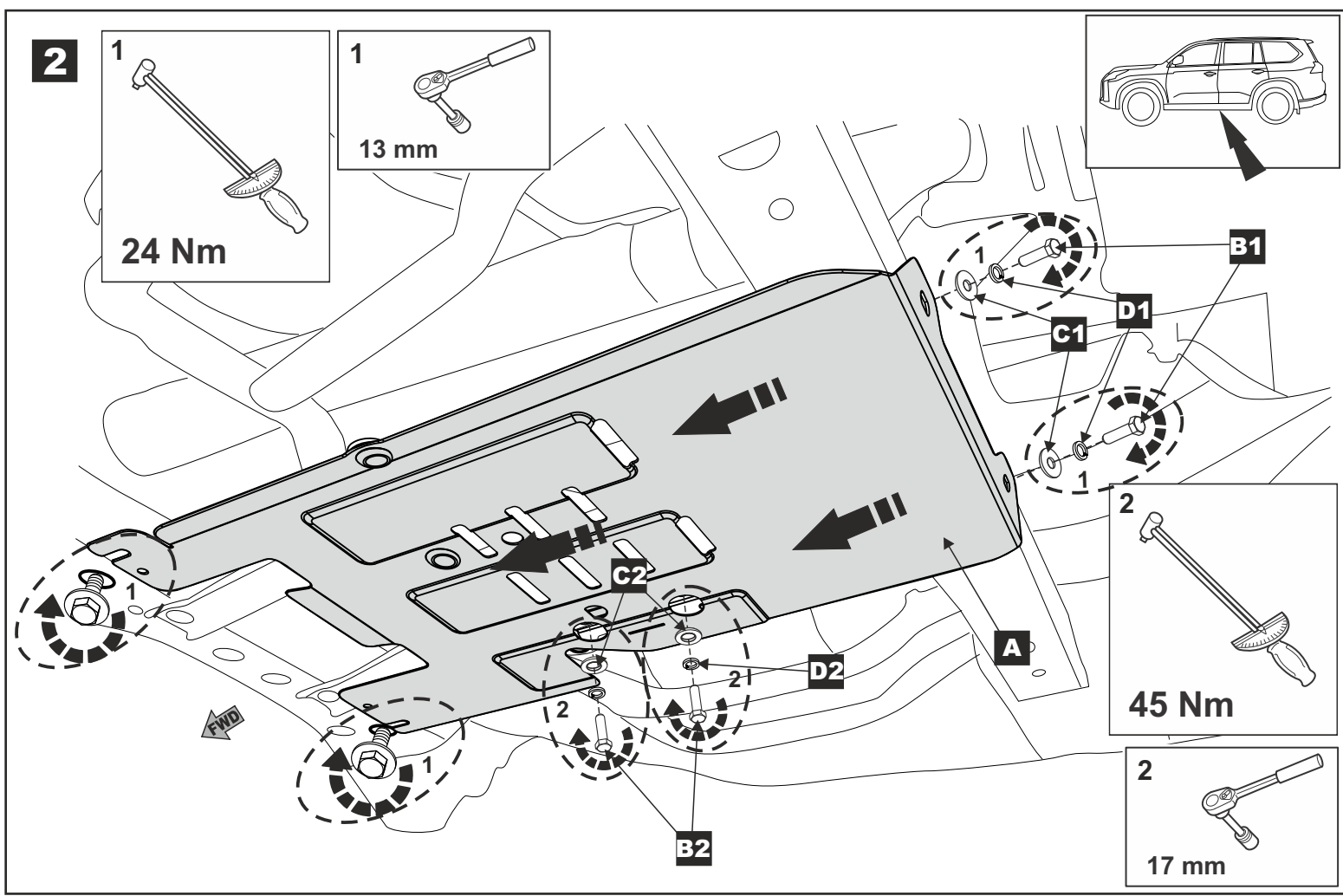
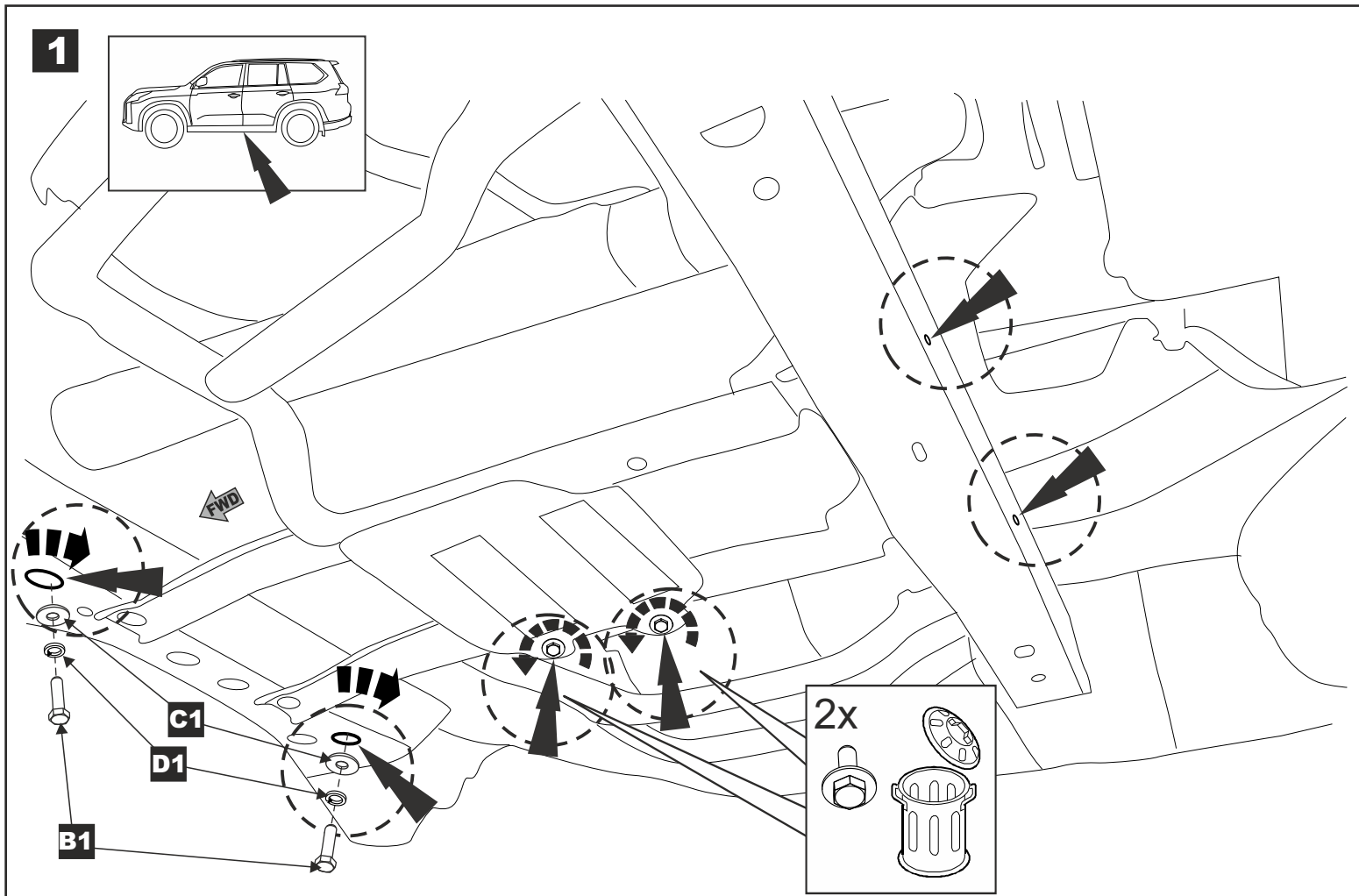

3

