

# Installation instructions for KZNG5-02672-00, KZNG5-02673-00 Under Run Reduction Gearbox Protective Shield

## LEXUS NX



Model Year:

**NX200T - 2014 -**

**NX200 - 2014 -**

Vehicle Code:

AGZ15L-AWTLTW

ZGZ15L-AWXLPW

Part Number:

Steel: KZNG5-02672-00  
Aluminium: KZNG5-02673-00



Weight:

Steel: 1,79 kg  
Aluminium: 0,83 kg



Installation Time:

10 min

KZNG5-02672-00, KZNG5-02673-00

**A**

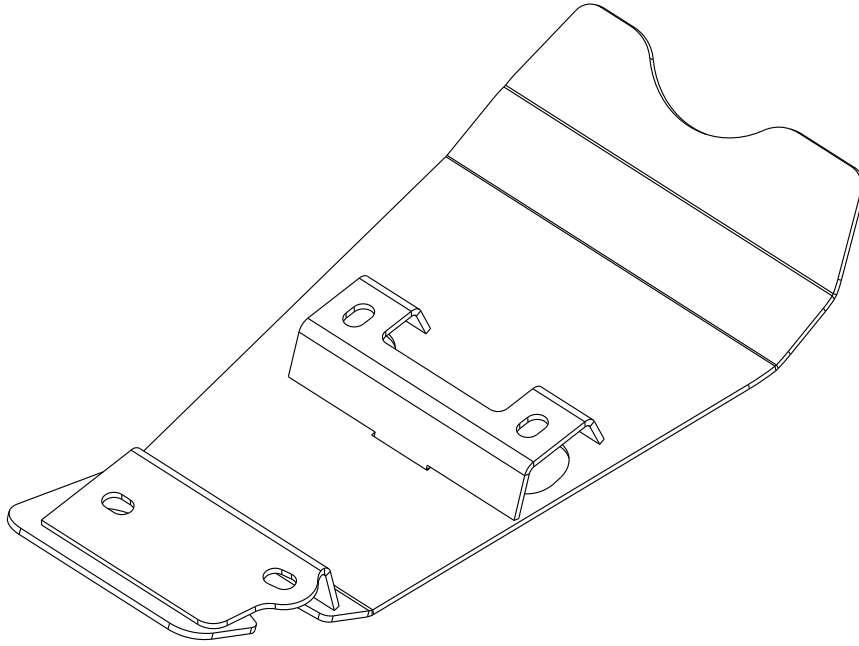

KZNG5-08920-60

**B**

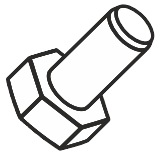

M8x20

4x

**C1**

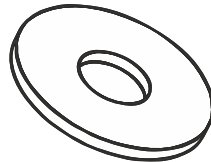

Ø 8

4x

**C2**

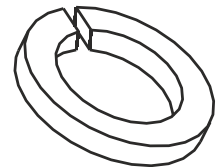

Ø 8G

4x

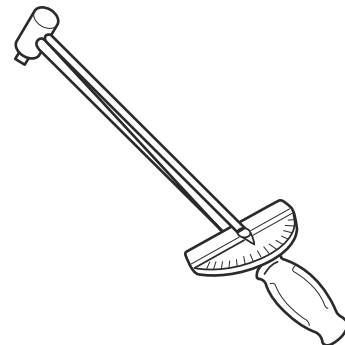
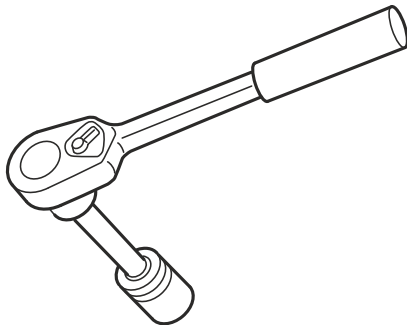

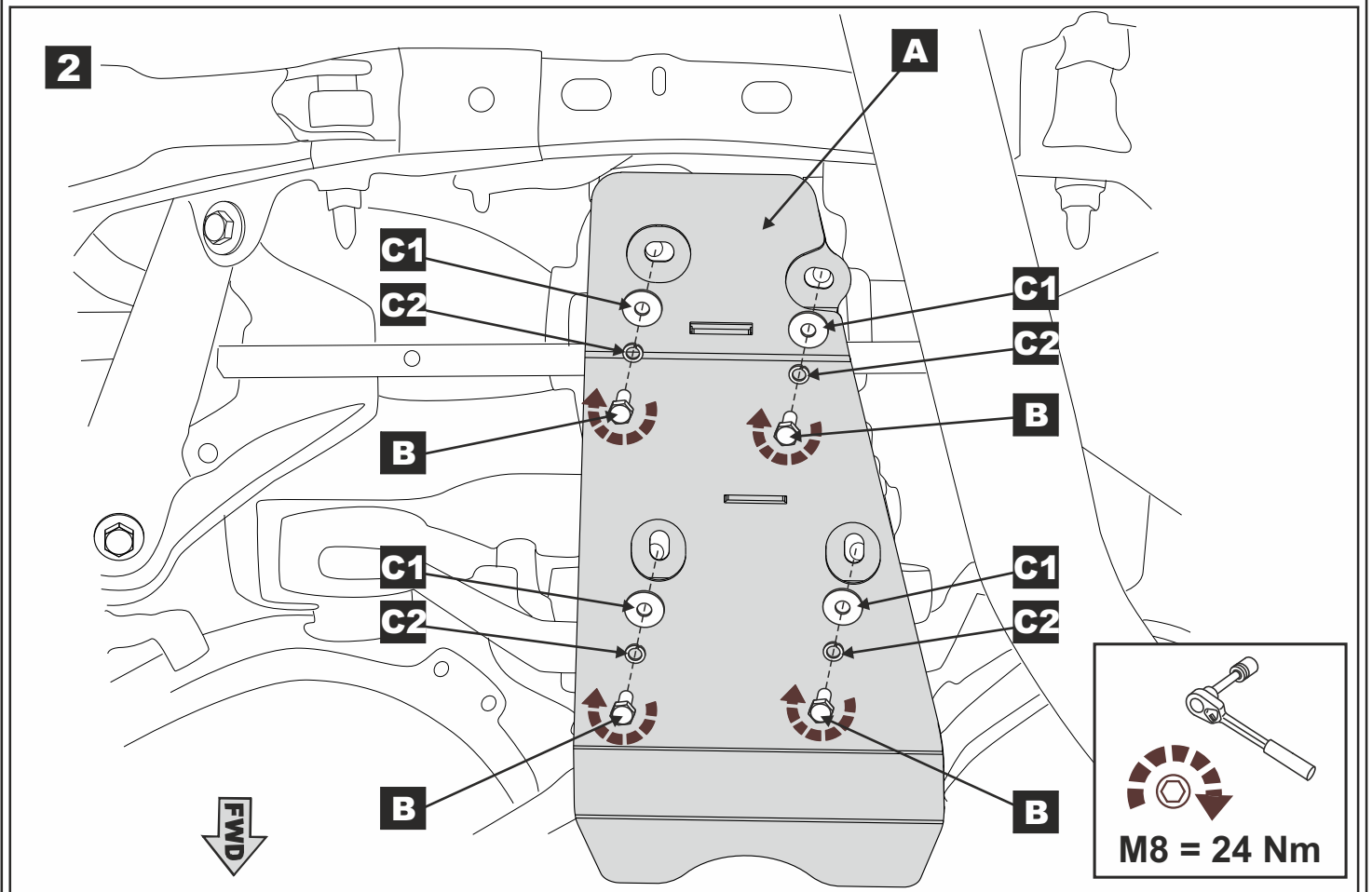
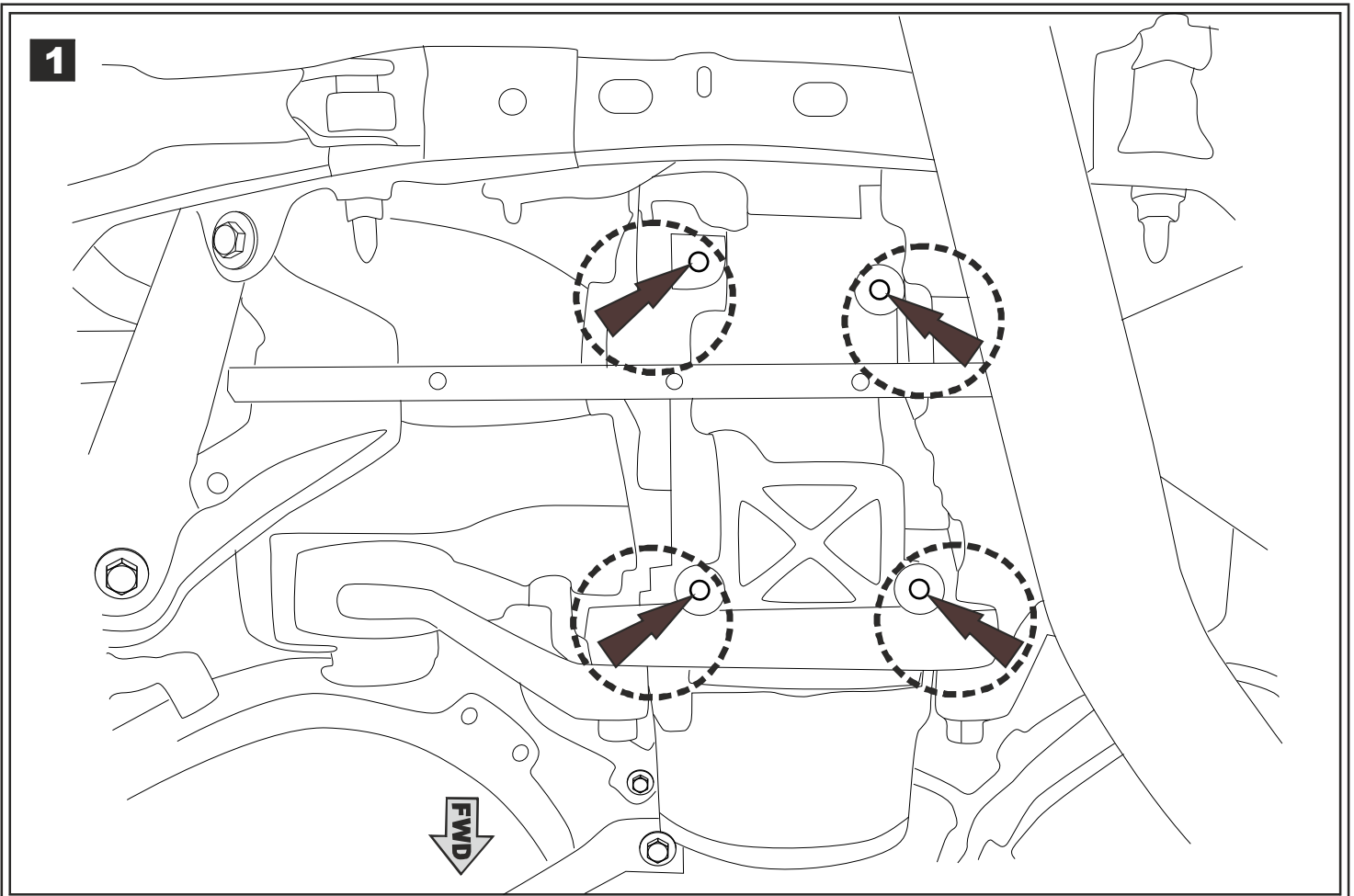

Part number:  
KZNG5-02672-00  
KZNG5-02673-00

Issue:  
0

Date:  
30/07/14

LEXUS NX 2014 -

Page:  
3/4

3

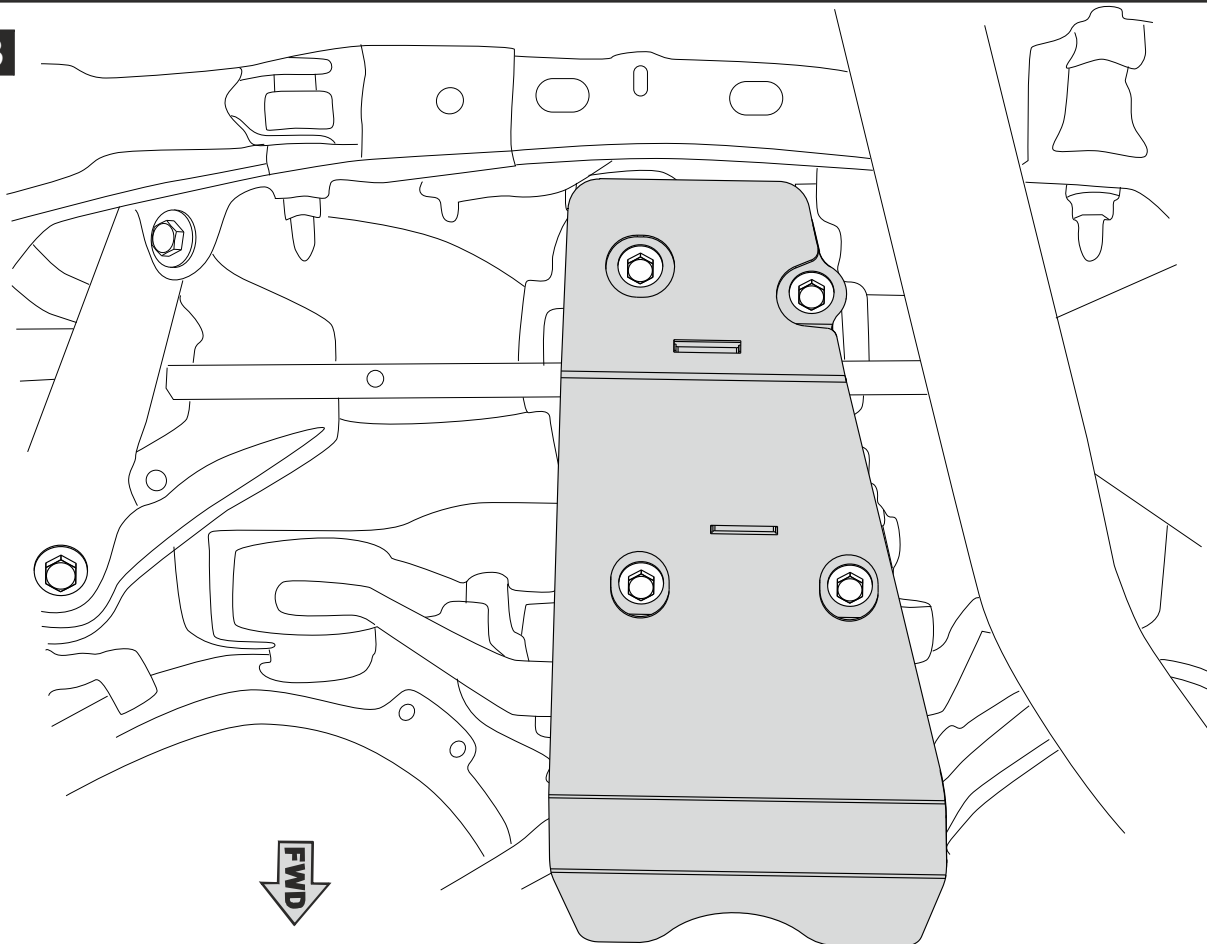

Part number:  
KZNG5-02672-00  
KZNG5-02673-00

Issue:  
0

Date:  
30/07/14

LEXUS NX 2014 -

Page:  
4/4