

Installation instructions for KZNG5-03834-00
Under Run Protective Shield TRANSMISSION CASE

**SKID PLATE INSTALLED TOGETHER WITH ENGINE BAY
PW41A-6000.**

TOYOTA LAND CRUISER 300



ModelYear	LAND CRUISER 2021-
Applicability:	CRUISER 3,5 AT 4WD
PartNumber	KZNG5-03834-00
 Weight	6,65 kg
 InstallationTime	30 min

KZNG5-03834-00

A

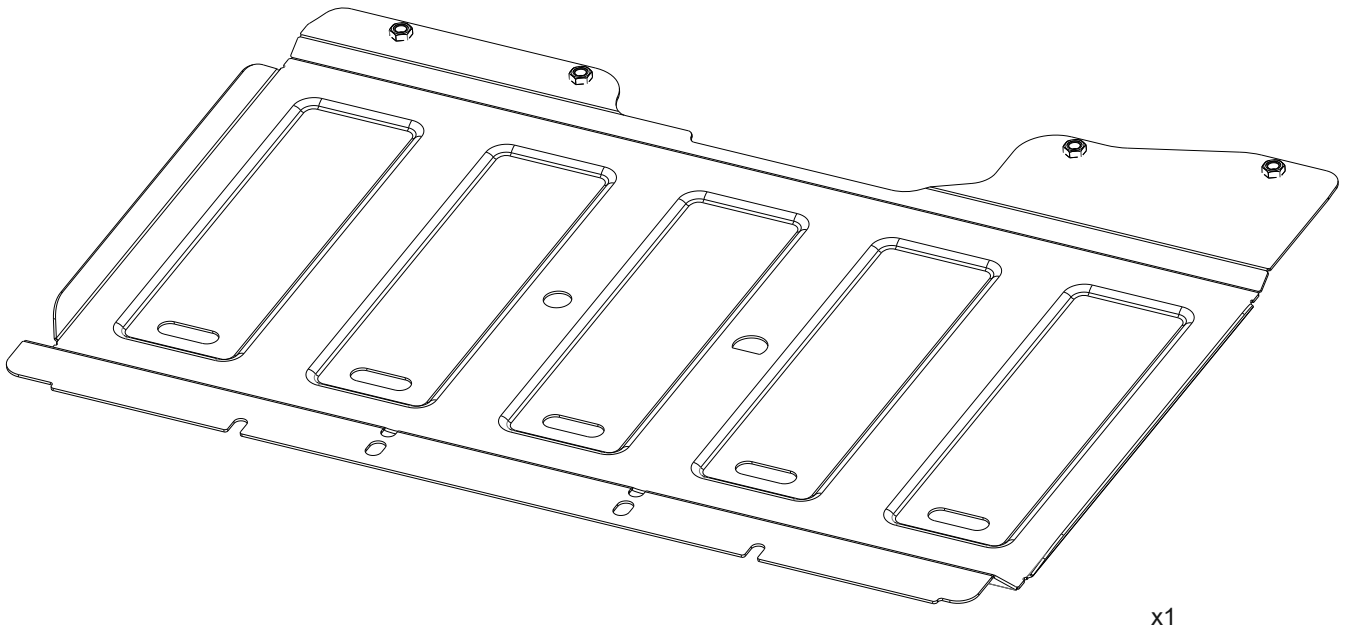

KZNG5-03834-60

B1

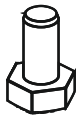

x6 M8x25

B2

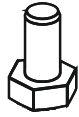

x2 M10x1,25x20

C

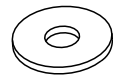

x6 Ø 8

E1

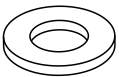

x2 Ø 8

E2

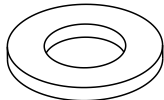

x2 Ø 10

F1



x6 Ø 8

F2



x2 Ø 10

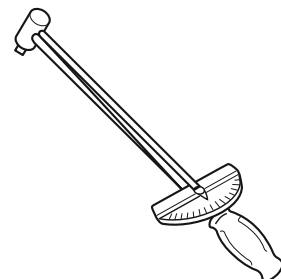
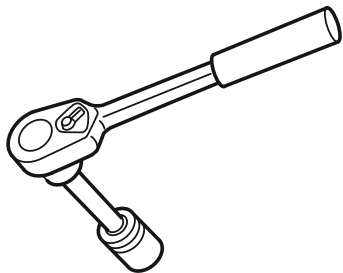

1

PW41A-6000

FWD

Regular fastener

Regular fastener

2

FWD

C

E1

F1

E1

F1

B1

3

